

### MOST POPULAR FUEL CELL BLADDER COVER PLATES & NUT-RINGS

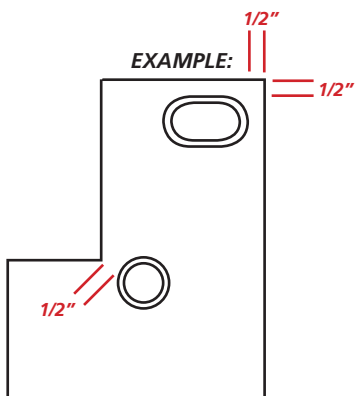

#### NOTES:

1. Cover plates available separately
2. Nut-rings available only as integral component of fuel cell bladder
3. All nut-rings shown are **SAE** thread 1/4 - 28
4. Corresponding nut-rings available in **metric** thread **M6**, but only as integral component of fuel cell bladder:  
 2.18" - 6 PART# TF494 M6  
 3" - 6 PART# TF435 M6  
 4.75" - 12 PART# TF412 M6  
 4" x 6" - 6 PART# TF447 M6  
 6" x 10" - 12 PART# TF386 M6

5. Outer edge of nut-ring must be **at least 1/2" (12mm)** from any edge or corner of bladder

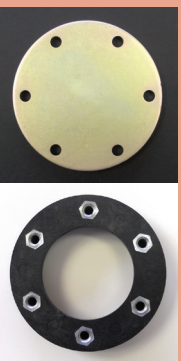
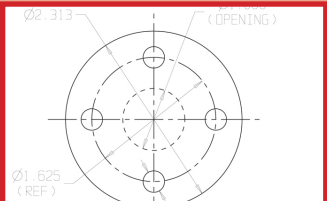
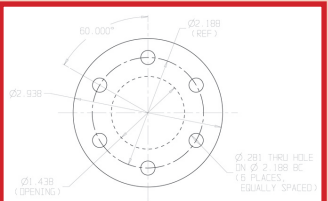
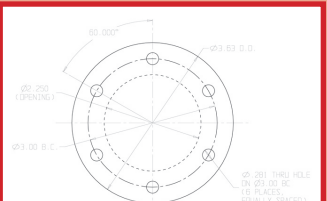
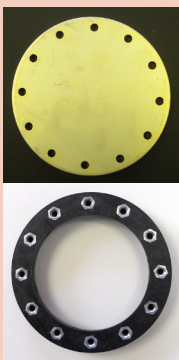
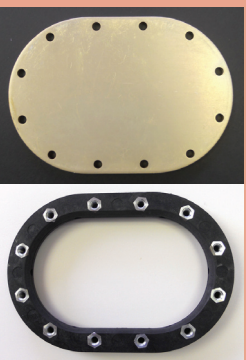
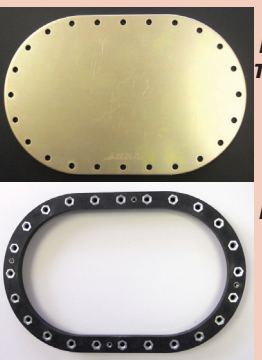
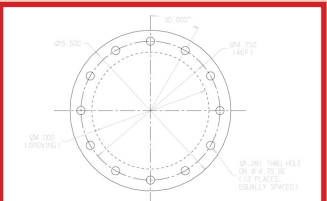
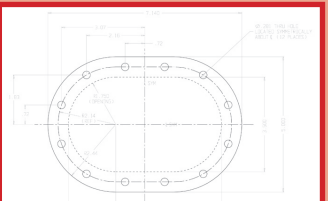
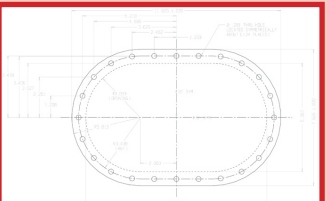

6. Custom nut-rings & covers available too

1.62" B.C. 4 Bolt	2.18" B.C. 6 Bolt	3" B.C. 6 Bolt
 <p><b>PART# TF266</b></p> <p><b>PART# TF260</b></p>	 <p><b>PART# TF494</b></p> <p><b>PART# TF489</b></p>	 <p><b>PART# TF108</b></p> <p><b>PART# TF435</b></p>
 <p><a href="#">Click for Detailed Drawing</a></p>	 <p><a href="#">Click for Detailed Drawing</a></p>	 <p><a href="#">Click for Detailed Drawing</a></p>
4.75" B.C. 12 Bolt	4" x 6" 12 Bolt	6" x 10" 24 Bolt
 <p><b>PART# TF107</b></p> <p><b>PART# TF412</b></p>	 <p><b>PART# TF109</b></p> <p><b>PART# TF447</b></p>	 <p><b>PART# TF110A</b></p> <p><b>PART# TF386</b></p>
 <p><a href="#">Click for Detailed Drawing</a></p>	 <p><a href="#">Click for Detailed Drawing</a></p>	 <p><a href="#">Click for Detailed Drawing</a></p>